

ALPHA STUD WELD

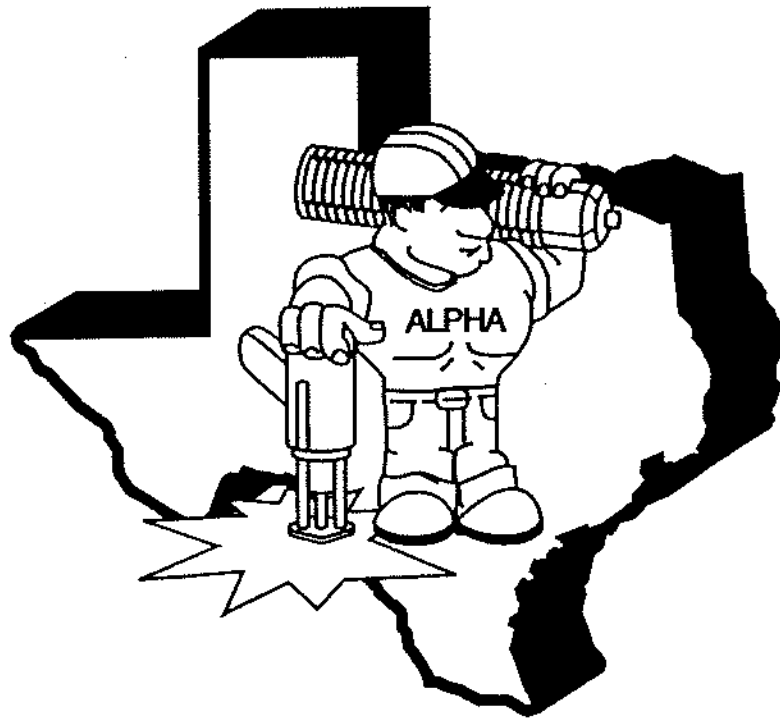

5121 STEADMONT
HOUSTON, TX. 77040

(713)460-5118 FAX: (713)460-8786
NATIONAL WATS (800)468-5118

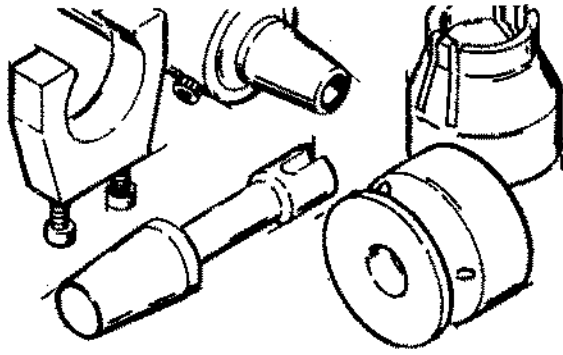

ALPHA STUD WELD

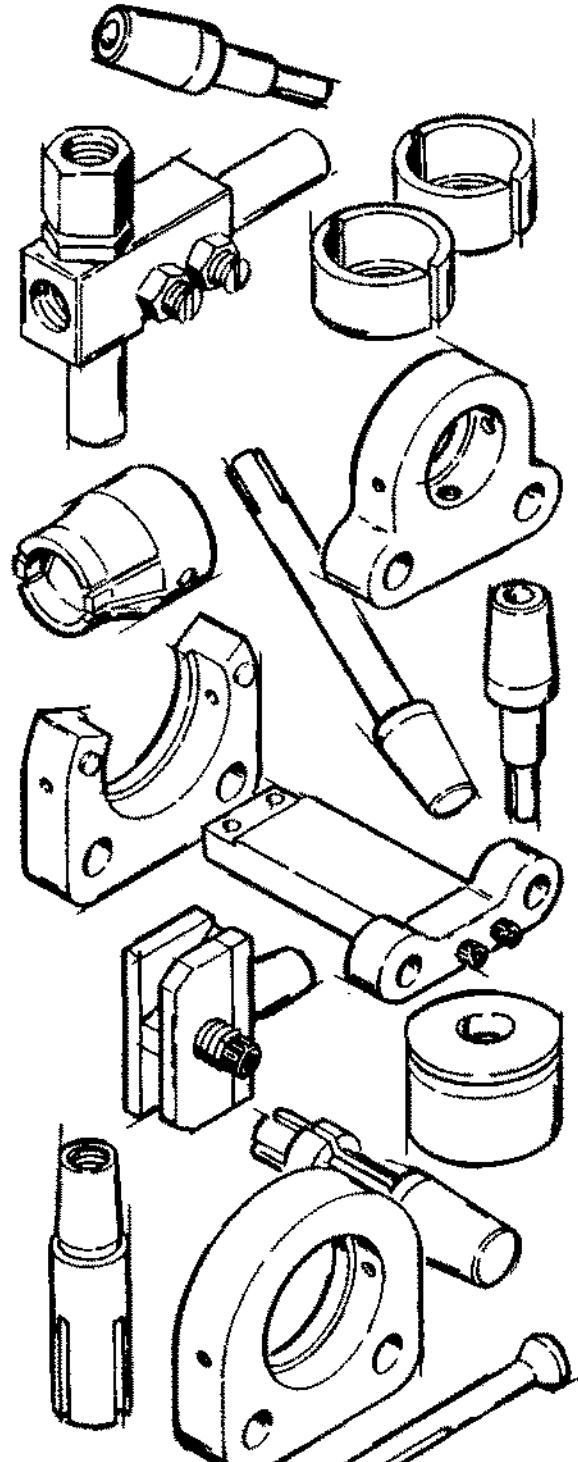

Accessories Specifications

STANDARD ACCESSORIES/CHUCKS

Standard Length Straight Style Chucks

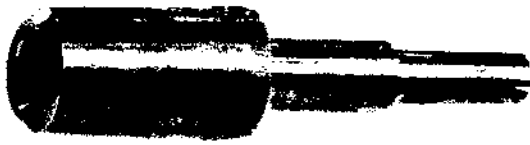

PART NO.	STUD DIA.	LENGTH
ACN-012	1/8" & 11ga.	2.625"
ACN-014	#6 & 10ga.	2.625"
ACN-016	#8	2.625"
ACN-018	#10	2.625"

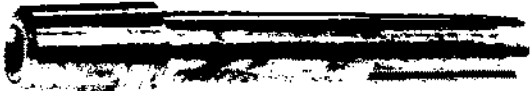

PART NO.	STUD DIA.	LENGTH
ACN-025	1/4"	2.500"
ACN-031	5/16"	2.500"
ACN-037	3/8"	2.500"
ACN-043	7/16"	2.500"
ACN-050	1/2" *	2.500"

* Also Used With 1/4" Headed Anchor.



PART NO.	STUD DIA.	LENGTH
ACN-062	5/8"	3.00"
ACN-075	3/4" *	3.00"
ACN-087	7/8"	3.00"

* Also Used With 3/8" Headed Anchor.

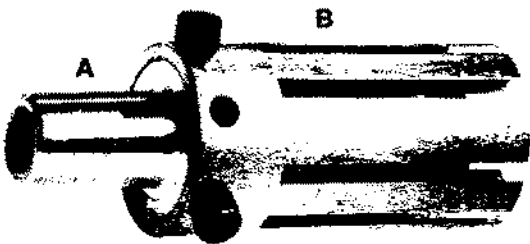

PART NO.	STUD DIA.	LENGTH
ACH-050	1" *	3.625"
ACH-050-1	1" (A) Base Only	
ACH-050-2	1" (B) Sleeve	

* Also Used With 1/2" Headed Anchor.

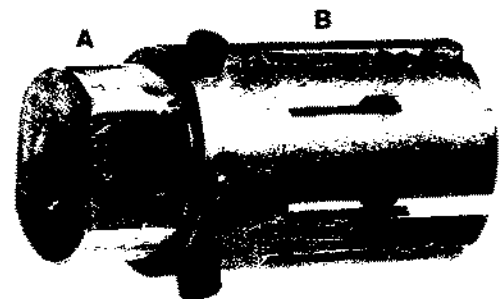

PART NO.	STUD DIA.	LENGTH
ACH-075	1 1/4" *	3.625"
ACH-087	1 3/8" **	3.625"
ACH-075-1	1 1/4" (A) Base	
ACH-087-1	1 3/8" (A) Base	
ACH-075-2	1 1/4" (B) Sleeve	
ACH-087-2	1 3/8" (B) Sleeve	
ACH-075-3	1 1/4" Allen Screw	
ACH-087-3	1 3/8" Allen Screw	

* Used With 5/8" & 3/4" Headed Anchors.

** Used With 7/8" Headed Anchors.

STANDARD ACCESSORIES/CHUCKS

Long Length Straight Style Chucks

PART NO.	STUD DIA.	LENGTH
ACM-025	1/4"	3.875"
ACM-031	5/16"	3.875"
ACM-037	3/8"	3.875"
ACM-043	7/16"	3.875"
ACM-050	1/2"	3.875"

(Adjustable Depth Stop)

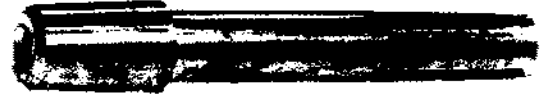

PART NO.	STUD DIA.	LENGTH
ACL-025	1/4"	4.750"
ACL-031	5/16"	4.750"
ACL-037	3/8"	4.750"
ACL-043	7/16"	4.750"
ACL-050	1/2"	4.750"

(Fixed Chuck Depth 1/2")

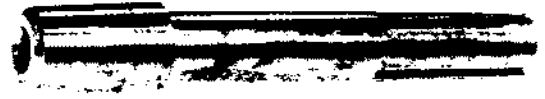

PART NO.	STUD DIA.	LENGTH
ACL-062	5/8"	4.750"
ACL-075	3/4"	4.750"

(Fixed Chuck Depth 1/2")

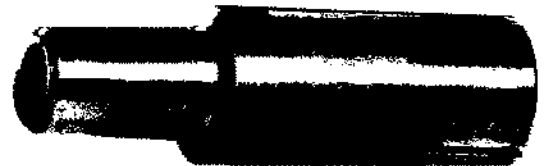

Rectangular Style Chucks

PART NO.	STUD SIZE	LENGTH
ACR-CA	1/8" x 1/4"	2.500"
ACR-CB	1/8" x 3/8"	3.000"

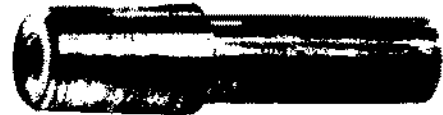

PART NO.	STUD SIZE	LENGTH
ACR-CC	1/8" x 5/8"	3.000"



PART NO.	STUD SIZE	LENGTH
ACR-CE	1/8" x 1"	3.250"
ACR-DE	3/16" x 1"	3.250"
ACR-DD	3/16" x 3/4"	3.250"
ACX-011	1/4" x 1 1/4"	3.500"



ALPHA STUD WELD Inc.

HOUSTON, TX. 77040 713-460-5118 FAX 713-460-8786 800-468-5118

STANDARD ACCESSORIES/CHUCK

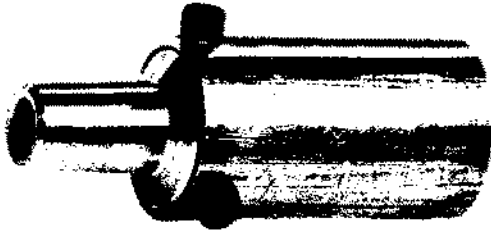

PART NO.	STUD DIA.	LENGTH
ACR-CH	1/8"x7/8"	3.00"
ACR-DD	3/16"x3/4"	3.00"

PART NO.	STUD DIA.	LENGTH
ACX-011	1/4"x1 1/2"	3.00"

Male Style Chucks (For Tapped or Drilled Studs)

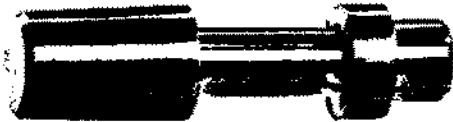

PART NO.	STUD DIA.	LENGTH
ACX-009-1	#10-32	2.500"
ACX-009-2	#10-24	2.500"
ACX-003-1	1/4-20	2.500"
ACX-003-2	5/16-18	2.500"
ACX-003-3	3/8-16	2.500"
ACX-003-4	1/2-13	2.500"
ACX-003-5	5/8-11	2.500"

90° Bent Stud Chucks

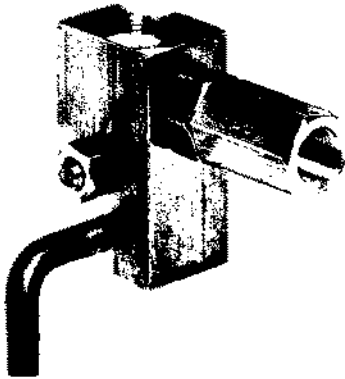

PART NO.	STUD DIA.
ACB-025	1/4"
ACB-037	3/8"
ACB-043	7/16"
ACB-050	1/2"
ACB-062	5/8"
ACB-075	3/4"

Eyebolt Chucks

PART NO.	STUD DIA.	LENGTH
ACE-031	5/16"	2.625"
ACE-037	3/8"	2.625"



SPECIAL ACCESSORIES/CHUCKS

Miscellaneous Chucks

PART NO.	DESCRIPTION
ACX-010	CHUCK ADAPTER
ACX-011	CONNECTOR STUD

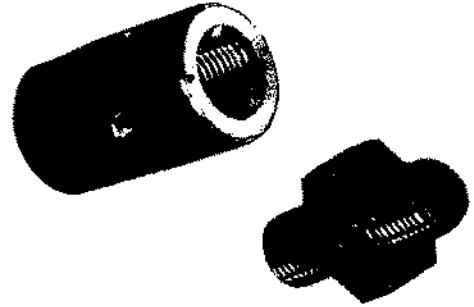

PART NO.	DESCRIPTION
AMT- 0003	TAPERED THREADED ADAPTER

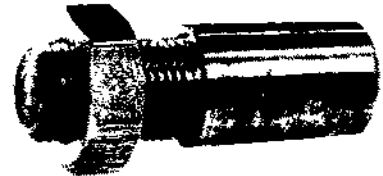

STANDARD ACCESSORIES/GRIPS

Copper Ferrule Grips

PART NO.	STUD DIA.	B	L
AGN-013	#6	.875	.875
AGN-016	#8	.875	.875
AGN-019	#10	.875	.875
AGN-025	1/4"	.875	.875
AGN-031	5/16"	.875	.875
AGN-037	3/8"	.875	.875
AGN-043	7/16"	.875	.875
AGN-050	1/2"	.875	.875
AGN-062	5/8"	1.156	1.000
AGN-075	3/4"	1.156	1.000
AGN-087	7/8"	1.750	1.000

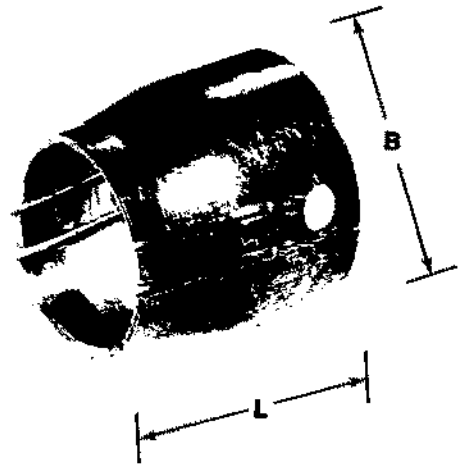

ALPHA STUD WELD Inc.

HOUSTON, TX. 77040 713-460-5118 FAX 713-460-8786 800-468-5118

STANDARD ACCESSORIES/GRIPS

Stand Length Split Or Open Copper Ferrule Grips

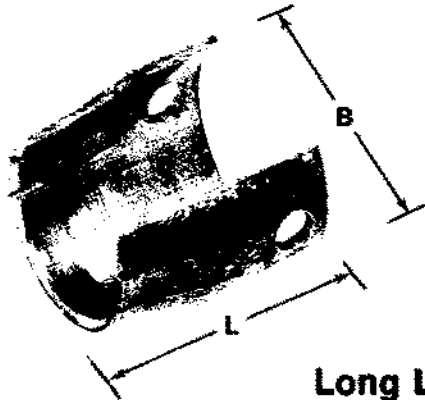

PART NO.	STUD DIA.	B	L
AGC-025	1/4"	.875	.875
AGC-031	5/16"	.875	.875
AGC-037	3/8"	.875	.875
AGC-043	7/16"	.875	.875
AGC-050	1/2"	.875	.875
AGC-062	5/8"	1.156	1.000
AGC-075	3/4"	1.156	1.000
AGC-087	7/8"	1.750	1.000

Long Length Split Or Open Copper Ferrule Grips

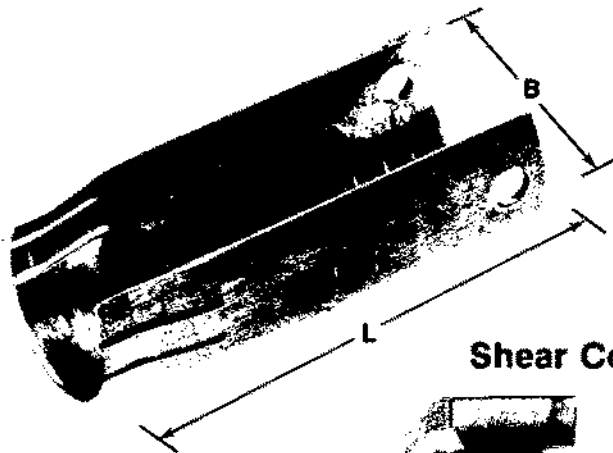

PART NO.	STUD DIA.	B	L
AGD-025	1/4"	.875	1.500
AGD-037	3/8"	.875	2.000
AGD-043	7/16"	.875	2.000
AGD-050	1/2"	.875	2.000
AGD-062	5/8"	1.156	2.000
AGD-075	3/4"	1.156	2.375

Shear Connector Ferrule Grips



PART NO.	STUD DIA.	I.D.	O.D.
AGH-050	1/2"	.650	1.750
AGH-062	5/8"	.785	1.750
AGH-075	3/4"	1.030	1.750
AGH-087	7/8"	1.210	1.750

STANDARD ACCESSORIES/FEET

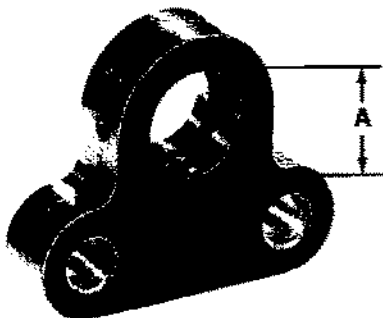

Standard Feet

PART NO.	DESCRIPTION
AB-1-N	SMALL FOOT (1/8" to 1/2")

ALPHA STUD WELD Inc.

HOUSTON, TX. 77040 713-460-5118 FAX 713-460-8786 800-468-5118



STANDARD ACCESSORIES/FEET

PART NO.	DESCRIPTION	A
AB-2-N	MEDIUM FOOT	1.156"



PART NO.	DESCRIPTION	A
AB-3-N	LARGE FOOT	1.750"



Standard Split or Open Feet

PART NO.	DESCRIPTION	A
AB-1-C	SMALL FOOT	.875"

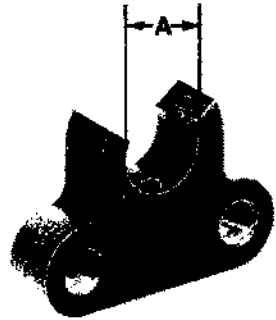

PART NO.	DESCRIPTION	A
AB-2-C	MEDIUM FOOT	1.156"

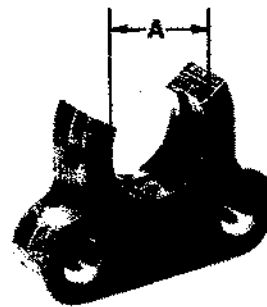

PART NO.	DESCRIPTION	A
AB-3-C	LARGE FOOT	1.750"

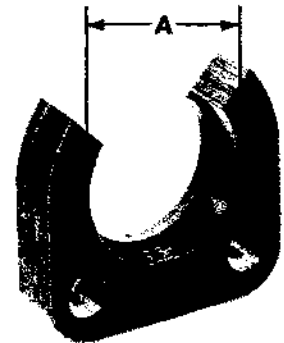

Shear Connector Bipod Foot

PART NO.	DESCRIPTION	A
ABX-009	BIPOD FOOT	1.750"



ALPHA STUD WELD Inc.

HOUSTON, TX. 77040 713-460-5118 FAX 713-460-8786 800-468-5118

SPECIAL ACCESSORIES/MISC.

Refractory Anchor Accessories

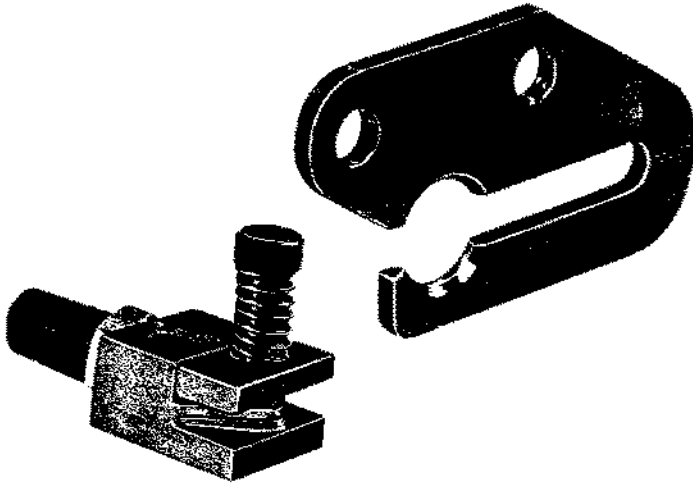

PART NO.	S4 "Y" ANCHOR
ACY-025	1/4" CHUCK
AQY-025	1/4" FERRULE FOOT PLATE
ABY-018	3/16" CHUCK
ARY-018	3/16" FERRULE FOOT PLATE

WELD THRU DECK ACCESSORIES

Ferrule Holder

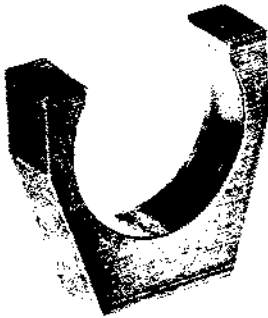

PART NO.	STUD DIA.	FERRULE
AB-0060-2	3/4"	ZFF-075

Ferrule Holder



PART NO.	STUD DIA.	FERRULE
AB-0060-1	3/4"	ZFF-075
AB-0060-3	7/8"	ZFW-087

Foot Extension

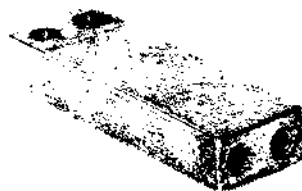

PART NO.	LENGTH
AB-0021-2	3"

ALPHA STUD WELD Inc.

HOUSTON, TX. 77040 713-460-5118 FAX 713-460-8786 800-468-5118

WELD THRU DECK ACCESSORIES

Foot

PART NO.	DESCRIPTION
AB-0021-1	INSULATOR MOUNT



Foot Extension Assembly

PART NO.	DESCRIPTION
AB-0021	FOOT EXTENSION ASSEMBLY

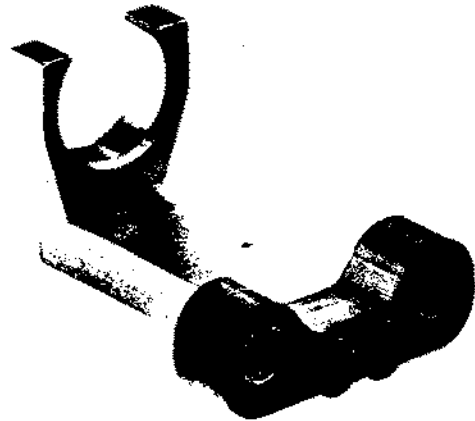

STANDARD ACCESSORIES/MISC.

Ferrule Tubing

PART NO.	STUD DIA.	I.D.	O.D.	LENGTH
AMP-016	#8	.291	.360	32"
AMP-019	#10	.305	.375	32"
AMP-025	1/4"	.380	.500	32"
AMP-031	5/16"	.445	.562	32"
AMP-037	3/8"	.505	.625	32"
AMP-043	7/16"	.585	.687	32"
AMP-050	1/2"	.650	.750	32"
AMP-062	5/8"	.785	.906	32"
AMP-075	3/4"	1.030	1.156	32"



ALPHA STUD WELD Inc.

HOUSTON, TX. 77040 713-460-5118 FAX 713-460-8786 800-468-5118

STANDARD ACCESSORIES/MISC.

Ferrule Tube Bushings

PART NO.	STUD DIA.	O.D.	I.D.
AMB-016	#8	.360	.875
AMB-019	#10	.375	.875
AMB-025	1/4"	.500	.875
AMB-031	5/16"	.562	.875
AMB-037	3/8"	.625	.875
AMB-043	7/16"	.687	.875
AMB-050	1/2"	.750	.875
AMB-062	5/8"	.906	1.156



PART NO.	DESCRIPTION
AML-900	ADJUSTABLE LEG-9" LONG
AML-1400	ADJUSTABLE LEG-14" LONG
AML-1800	ADJUSTABLE LEG-18" LONG
AML-2400	ADJUSTABLE LEG-24" LONG
AML-3000	ADJUSTABLE LEG-30" LONG
AML-3600	ADJUSTABLE LEG-36" LONG



Ferrule Foot Plate

PART NO.	STUD DIA.	A
AQN-025	1/4"	.380
AQN-037	3/8"	.505
AQN-043	7/16"	.585
AQN-050	1/2"	.650
AQN-062	5/8"	.785
AQN-075	3/4"	1.030
AQN-087	7/8"	1.210

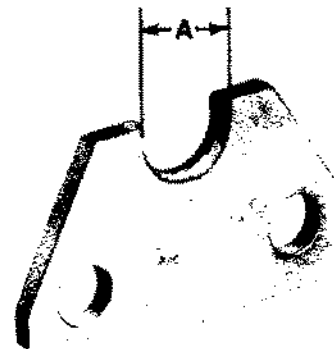

ALPHA STUD WELD Inc.

Insulation—Stud Welding Accessories

Collets & CHIP Chucks



SIZE / DESCRIPTION	PART NO.
12 Ga. or #4 B Collets	028-870
10 Ga. or #6 B Collets	003-631
3/16 or #10 B Collets	010-011



12 Ga. Closed-end Collets	028-865
10 Ga. Closed-end Collets	028-866



12 Ga. Collet Inserts	029-477
10 Ga. Collet Inserts	029-478

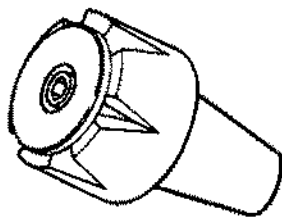

Contact Magnetic Chucks for Cupped Head Insul Pins (Universal)	029-616
--	---------

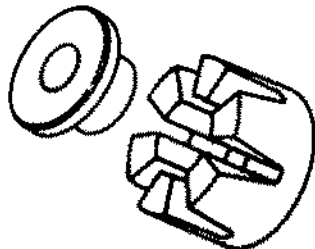

Magnets (for CHIP Chucks)	017-633
Conductor Plates (for CHIP Chucks)	029-615

Insulation—Stud Welding Accessories

Legs, Footpieces, Spark Shields, & Bushings

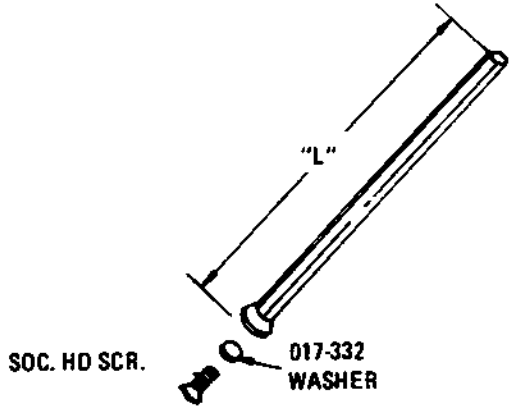

DESCRIPTION	PART NO.
7" Legs (KSM style)	000-355
10" Legs (KSM style)	000-358
7" Legs (Erico-Jones style)	028-847
12" Legs (Erico-Jones style)	028-855

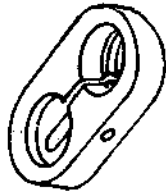

Closed Footpieces (accepts spark shield)	029-261
---	---------

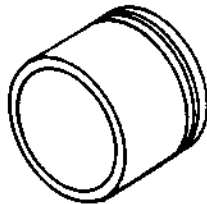

Spark Shields — 14 Ga.-#6 (Used with closed footpiece #029-261)	028-832
---	---------

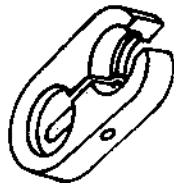

Small Split Footpieces (accepts bushing)	000-239
---	---------



Bushings—14 Ga.-#6 (Used with split footpiece #000-239)	000-253
--	---------

Insulation—Stud Welding Accessories

Collet Protectors & Stops

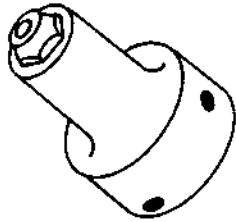

Collet Protectors

DESCRIPTION / SIZE	PART NO.
Assembly—14 Ga.-12 Ga.	028-837
Assembly—#4-10 Ga.	028-838
Body (Universal)	028-836



Collet Protector Inserts

14 Ga.-12 Ga.	028-834
#4-10 Ga.	028-835



Stops

Universal Stops for B Collet	029-476
------------------------------	---------